

RCP00202A/0105D

Features

- Unique coupler structure for wide band high directivity operation.
- Internal Detector and comparator with variable trip voltage for R/L measurement and high VSWR alarm. Alarm and \sim Alarm for convenient use.
- Wide dynamic range owing to log-slope detector
- R/L (dB) indicated by voltage output.
- Independent forward and reverse power monitor in log slope.



Specifications subject to change without notice.

Customer Service: Tel. 82-31-708-7575

Email: kijeon@rfcore.com

<http://www.rfcore.com>

Electrical Specification RCP00202A

RCP00202A/0105D

Parameter	Symbol	Typical	Units/Remarks
Bandwidth		20~200	MHz
Maximum handling power	Pw	100	Watt
Dynamic Range		1~100	Watts
Insertion Loss	IL	< 0.4	dB
Input VSWR,	VSWR	1.5:1	
Output VSWR	VSWR	1.5:1	
Return Loss Detector Slope	SRL	0.1	V / dB
Detector Accuracy		TBD	
Detector flatness over band		TBD	
Detector Linearity vs power input		TBD	
Detector Stability over Temperature		TBD	
Detector Response time		TBD	
Forward/Reverse Power Detector slope	SDEC	0.05	V/dB
Input Voltage	Vdc	5 +/-0.5	V
Current Consumption	Idc	200	mA
Alarm/~Alarm output		5V TTL	
Alarm Response Time		TBD	nsec
Detector port output impedance		1	kohm
RF Connector Type		N	female
Size (w/o Connector Extension)		86 x 90 x 27	mm
Operating Case Temperature		-20~70	degree C
Storage Temperature		-40~90	degree C
Vibration Condition		TBD	

Specifications subject to change without notice.

Customer Service: Tel. 82-31-708-7575

Email: kijeon@rfcore.com

<http://www.rfcore.com>

RFcore

This material is not to be supplied by other party than RFcore co., LTD

High Power Return Loss Detector

Typical Measured Data of RCP00202A

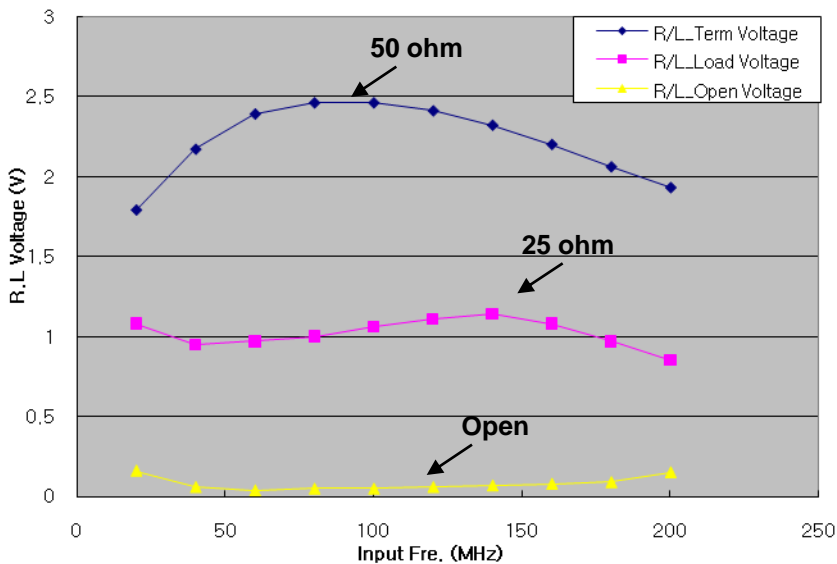
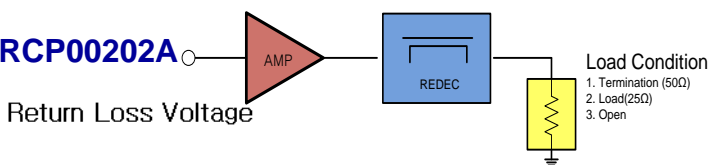

Forward Detector Voltage

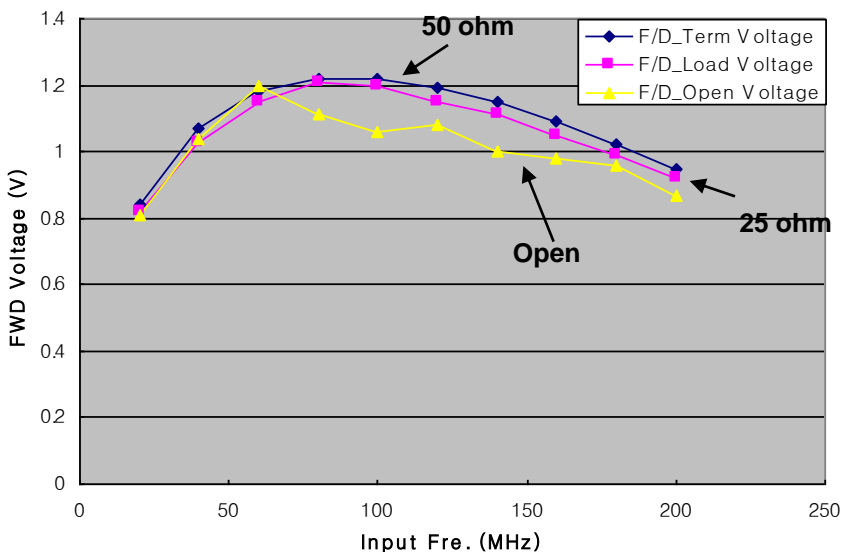

Specifications subject to change without notice.

Customer Service: Tel. 82-31-708-7575

Email: kijeon@rfcore.com

<http://www.rfcore.com>

RFcore

This material is not to be supplied by other party than RFcore co., LTD

High Power Return Loss Detector

Typical Measured Data of RCP00202A

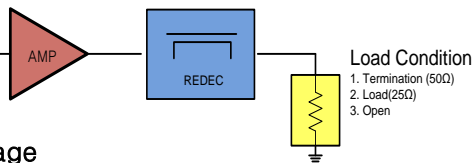

Forward Detector Voltage

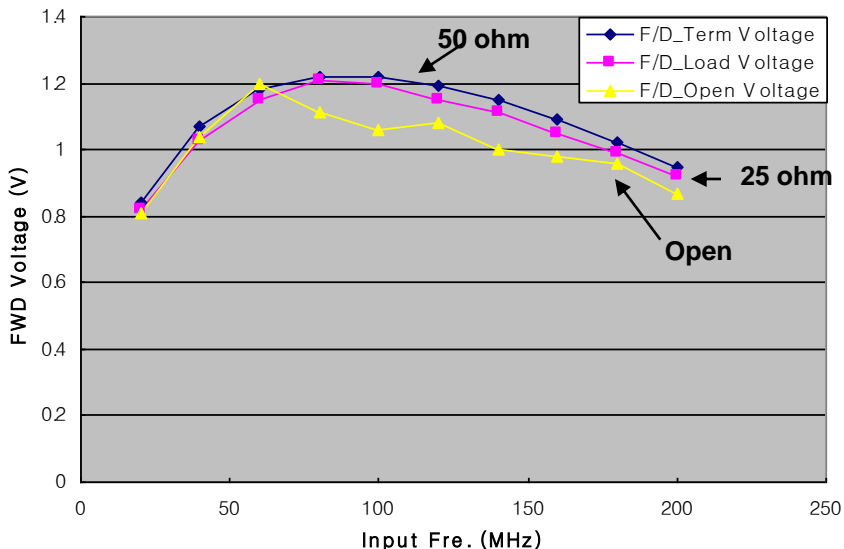

Reverse Detector Voltage

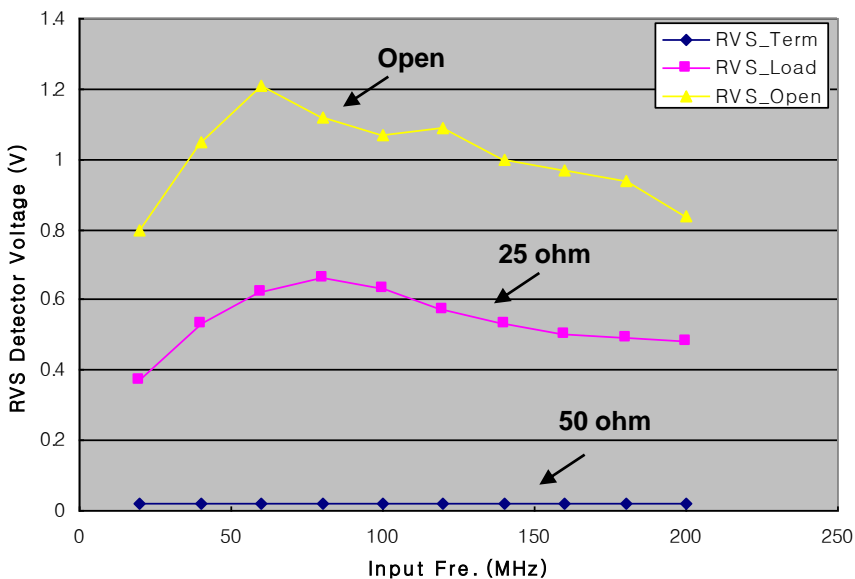

Specifications subject to change without notice.

Customer Service: Tel. 82-31-708-7575

Email: kijeon@rfcore.com

<http://www.rfcore.com>

RFcore

This material is not to be supplied by other party than RFcore co., LTD

Electrical Specification RCP0105D

Parameter	Symbol	Typical	Units/Remarks
Bandwidth		100~500	MHz
Maximum handling Power	Pw	300	Watt
Dynamic Range		1~300	Watts
Insertion Loss	IL	< 0.4	dB
Input VSWR,	VSWR	1.5:1	
Output VSWR	VSWR	1.5:1	
Return Loss Detector Slope	SRL	0.1	V / dB
Detector Accuracy		TBD	
Detector flatness over band		TBD	
Detector Linearity vs power input		TBD	
Detector Stability over Temperature		TBD	
Detector Response time		TBD	
Forward/Reverse Power Detector slope	SDEC	0.05	V/dB
Input Voltage	Vdc	5 +/-0.5	V
Current Consumption	Idc	200	mA
Alarm/~Alarm output		5V TTL	
Alarm Response Time		TBD	nsec
Detector port output impedance		1	kohm
RF Connector Type		N	female
Size (w/o Connector Extension)		86 x 90 x 27	mm
Operating Case Temperature		-20~70	degree C
Storage Temperature		-40~90	degree C
Vibration Condition		TBD	

RCP00202A/0105D

Specifications subject to change without notice.

Customer Service: Tel. 82-31-708-7575

Email: kijeon@rfcore.com

<http://www.rfcore.com>

RFcore

This material is not to be supplied by other party than RFcore co., LTD

High Power Return Loss Detector

Typical Measured Data of RCP0105D

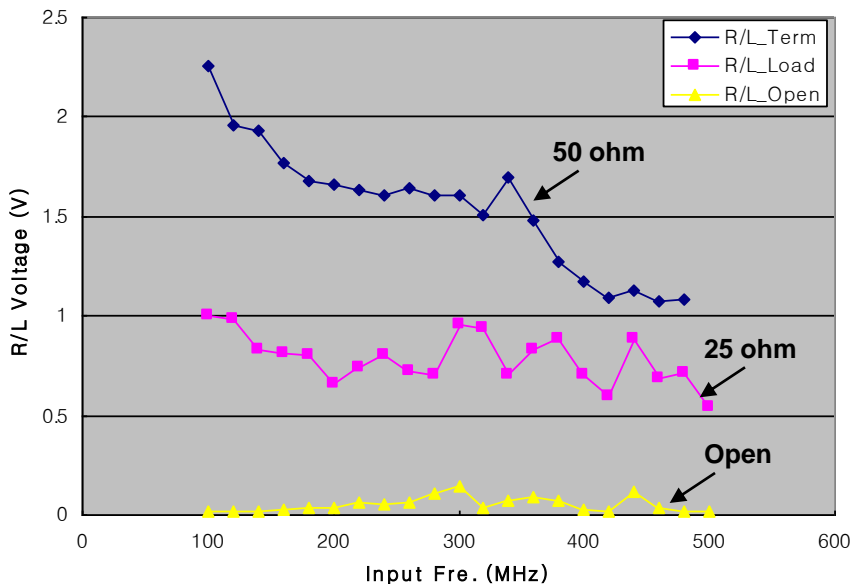
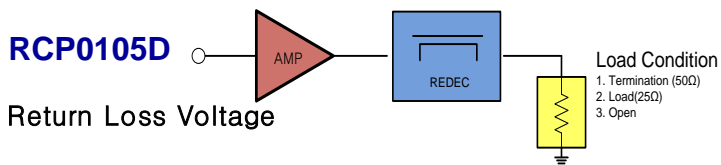

Forward Detector Voltage

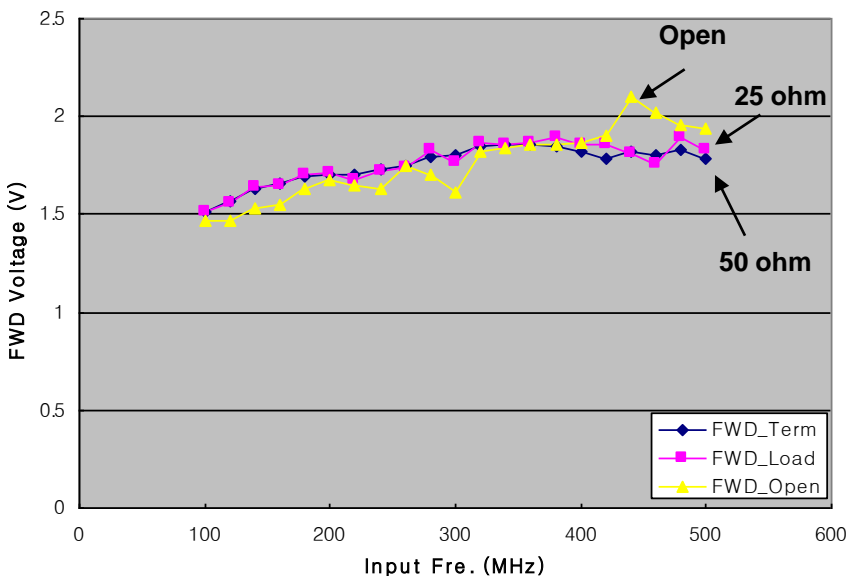

Specifications subject to change without notice.

Customer Service: Tel. 82-31-708-7575

Email: kijeon@rfcore.com

<http://www.rfcore.com>

RFcore

This material is not to be supplied by other party than RFcore co., LTD

High Power Return Loss Detector

Typical Measured Data of RCP0105D

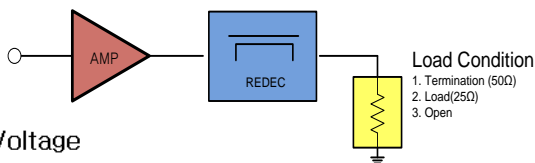

Forward Detector Voltage

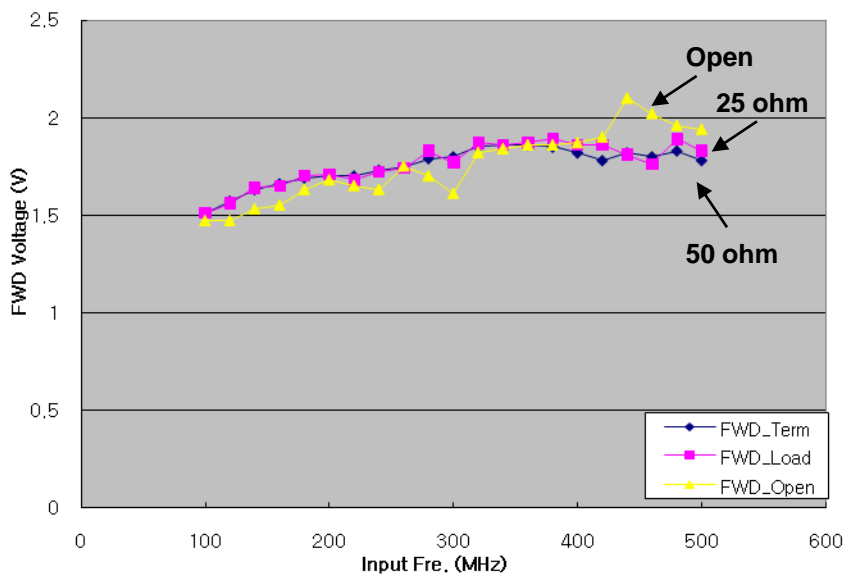

Reverse Detector Voltage

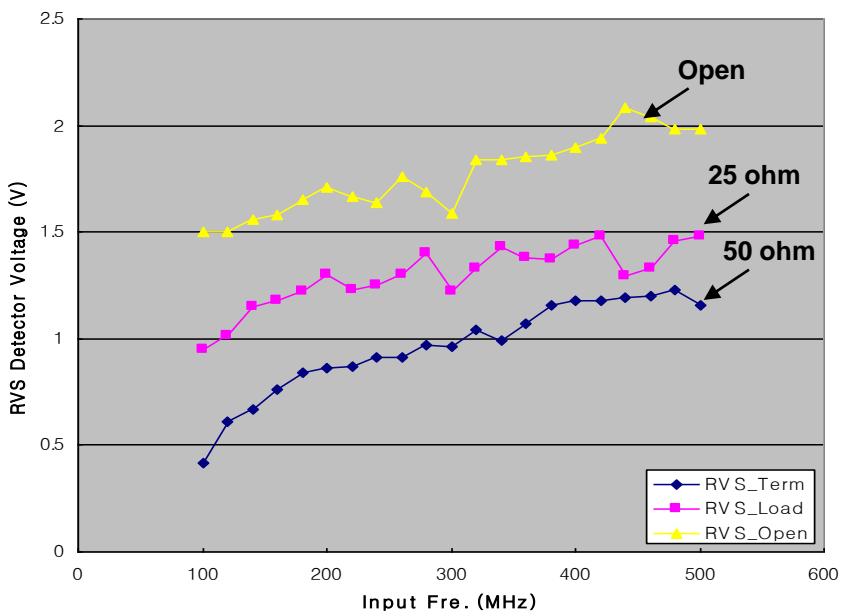

Specifications subject to change without notice.

Customer Service: Tel. 82-31-708-7575

Email: kijeon@rfcore.com

<http://www.rfcore.com>

RFcore

This material is not to be supplied by other party than RFcore co., LTD

Descriptions

RCPxxxx measures Return loss of Load connected output port by using directional coupler with high directivity.

RCPxxxx indicates measured Return Loss by voltage as bellow

$$V_{R/L(\text{return loss})} = \text{Return Loss(dB)} * 0.1 \pm 0.15V$$

For example, if the return loss of antenna is 10 dB, the $V_{R/L}$ is 1.0V. This module also deliver alarm and alarm with adjustable trip level. This adjustment can be done by user turning potentiometer.

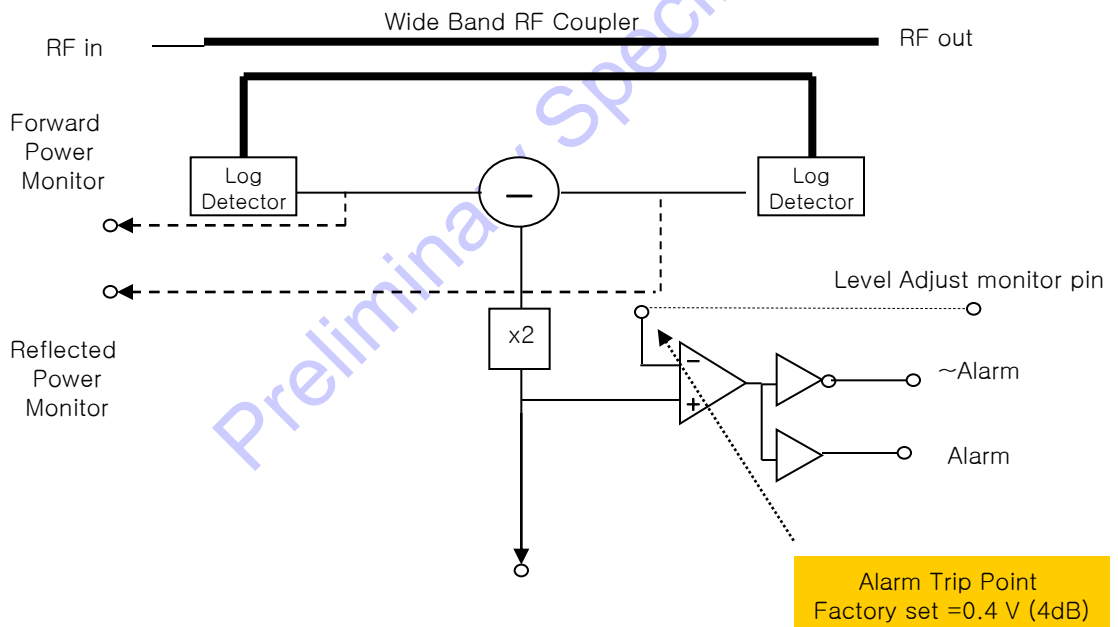

$$V_{out} (\text{pin \#4}) = \text{Return Loss of Load in dB} * 0.1 (V)$$

Simplified Block Diagram

Specifications subject to change without notice.

Customer Service: Tel. 82-31-708-7575

Email: kijeon@rfcore.com

<http://www.rfcore.com>

RFcore

This material is not to be supplied by other party than RFcore co., LTD

RCP00202A/0105D

Wide band directional coupler samples forward and reverse power at once and independently. Directivity of this coupler affects significantly on REDEC performance. Detector voltages for F/R are provided thru Molex pin for the purpose of power monitoring. Difference of Detector voltage is exactly physical quantity of Return Loss. For better comprehension, x 2 value come out thru Molex pin. Note that this device does not have accuracy as power meter or network analyzer. It has limitation on dynamic range, frequency flatness, detector linearity and accuracy. Frequency flatness was improved by utilizing frequency equalizer. It is not depicted in the block diagram for clearance. The accuracy and dynamic range will be supplied after further development.

Preliminary Specification

Specifications subject to change without notice.

Customer Service: Tel. 82-31-708-7575

Email: kijeon@rfcore.com

<http://www.rfcore.com>

RFcore

This material is not to be supplied by other party than RFcore co., LTD

RCP00202A/0105D

Brief Mechanical Description

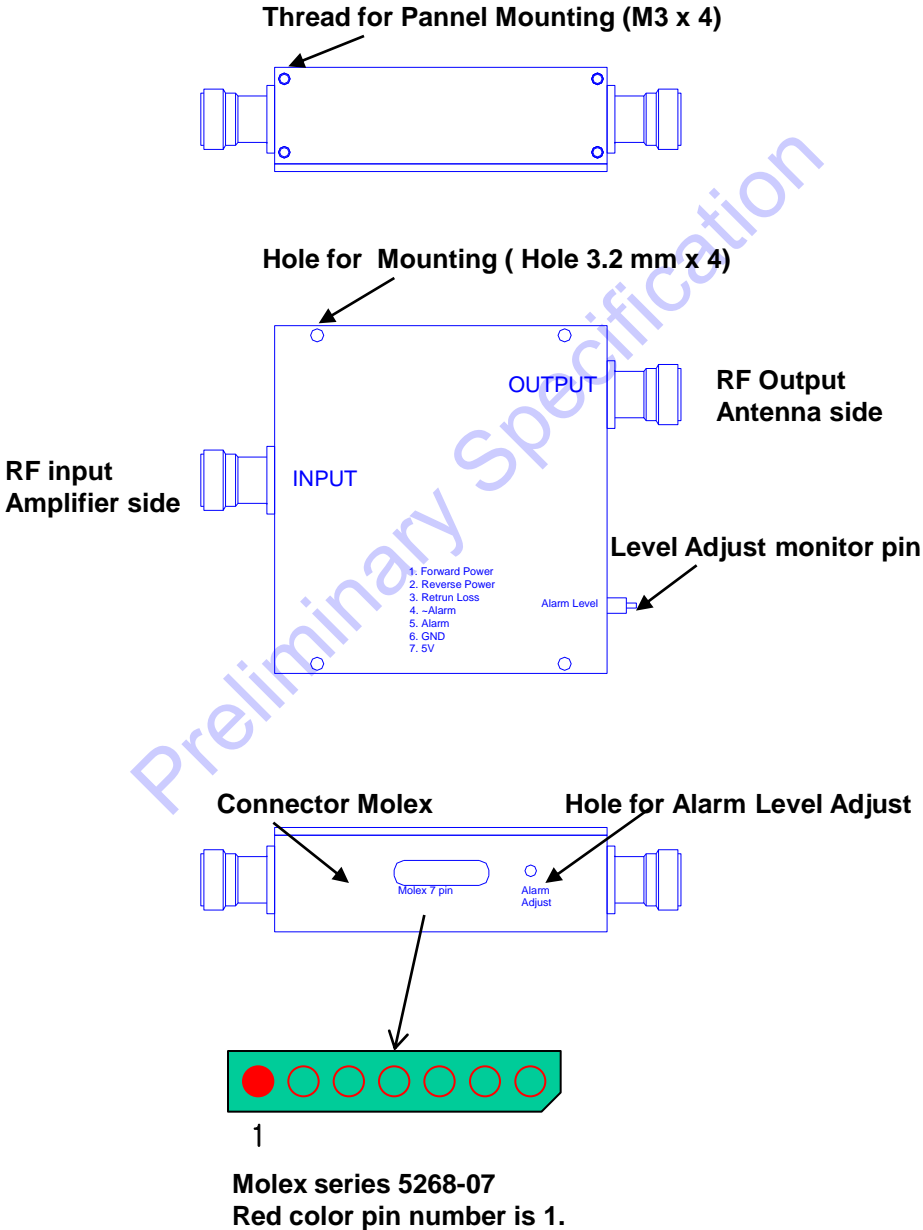

Specifications subject to change without notice.

Customer Service: Tel. 82-31-708-7575

Email: kijeon@rfcore.com

<http://www.rfcore.com>

Pin Description

Pin Name	Pin Description	Interface Schematic
RF Input	N type	
RF Output	N type	
Forward Power (Molex Pin1)	Forward Power Monitor with 0.05V/ dB	
Reverse Power (Molex Pin2)	Reverse Power Monitor with 0.05V/ dB	
Return Loss (Molex Pin3)	Return Loss in 0.1V/dB	
~Alarm (Molex Pin4)	~Alarm : 0V when R/L go over trip setting (Pin*) 5V @ normal	
Alarm (Molex Pin5)	Alarm : 5V when R/L go over trip setting (Pin*) 0V @ normal	
GND (Molex Pin6)	GND	
5V (Molex Pin7)	5V	
Alarm Level (Pin Feed Thru)	Adjust Trip Level Monitor	
Alarm Adjust (Hole)	Adjust Alarm Level	

RCP00202A/0105D

Specifications subject to change without notice.

Customer Service: Tel. 82-31-708-7575

Email: kijeon@rfcore.com

<http://www.rfcore.com>

RFcore

This material is not to be supplied by other party than RFcore co., LTD

Conceptual drawing of $V_{R/L}$ VS. Load Return Loss

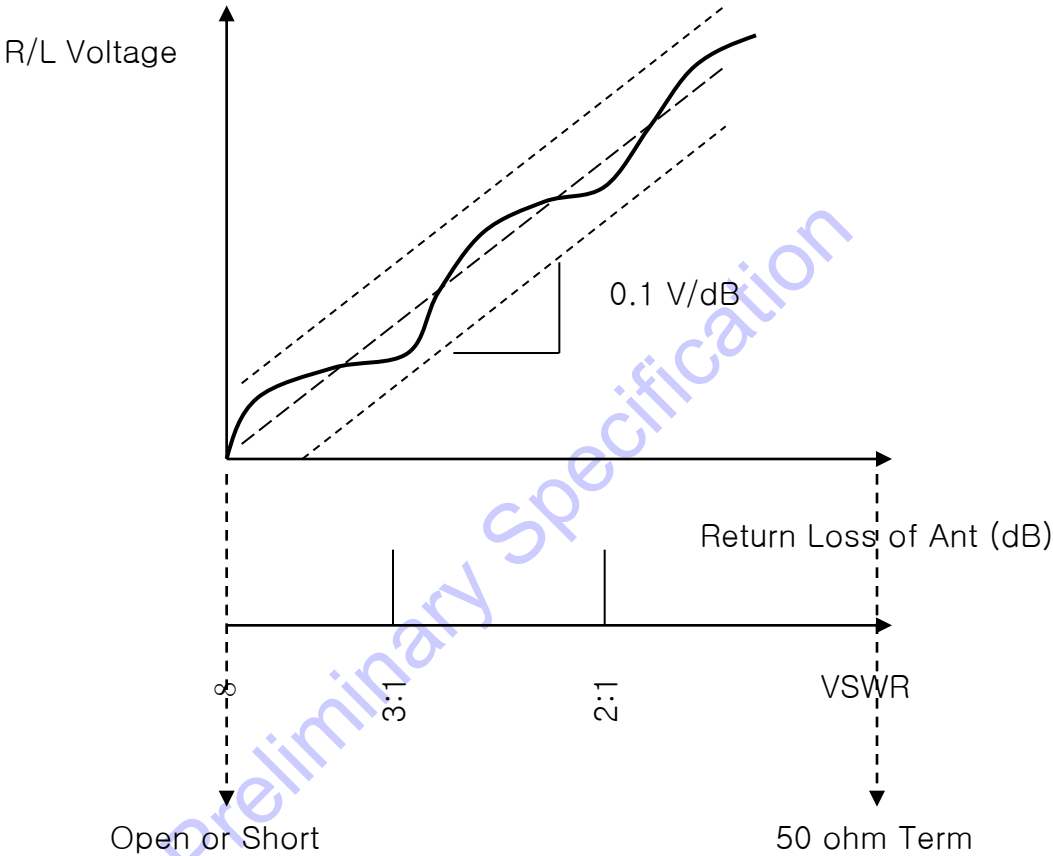

RCP00202A/0105D

Specifications subject to change without notice.

Customer Service: Tel. 82-31-708-7575

Email: kijeon@rfcore.com

<http://www.rfcore.com>



RCP00202A/0105D

Conceptual drawing of Detector Voltage VS. Input Power @ specific frequency

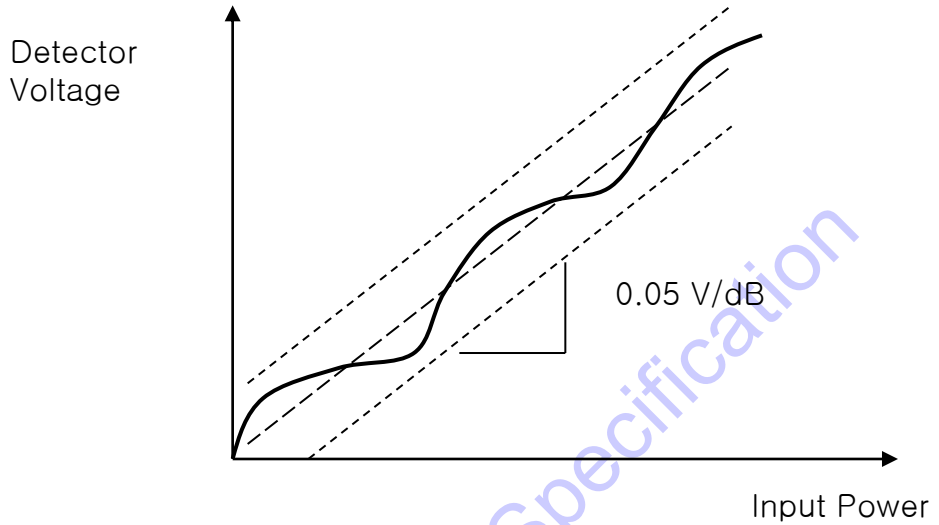

Conceptual drawing of Detector Voltage VS. Frequency @ Constant Power

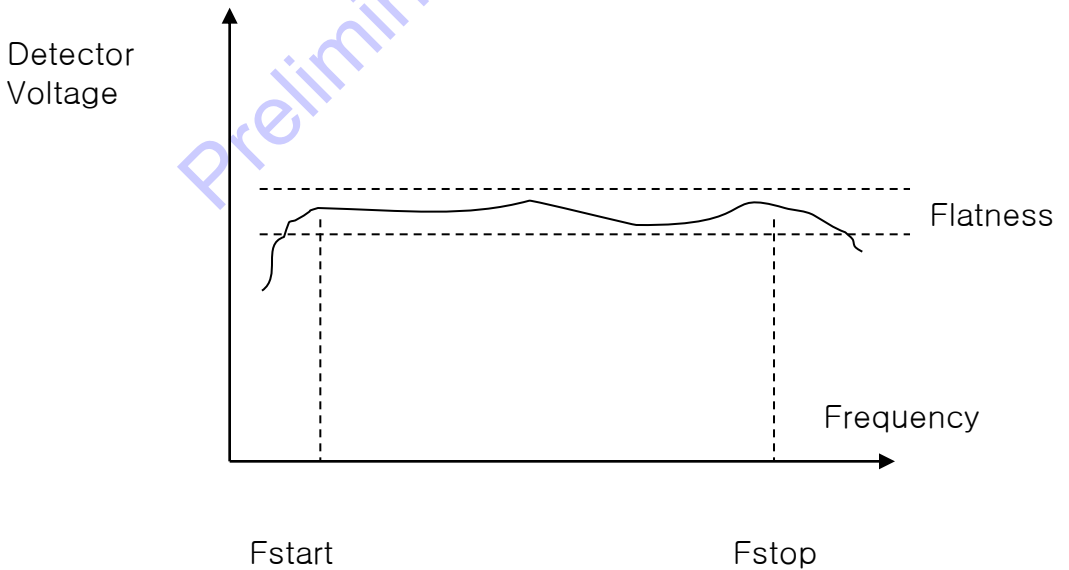

Specifications subject to change without notice.

Customer Service: Tel. 82-31-708-7575

Email: kijeon@rfcore.com

<http://www.rfcore.com>

RFcore

This material is not to be supplied by other party than RFcore co., LTD

Mechanical Dimensions (86 x 90 x 27 mm³)
for RCP00202A,RCP0105D

RCP00202A/0105D

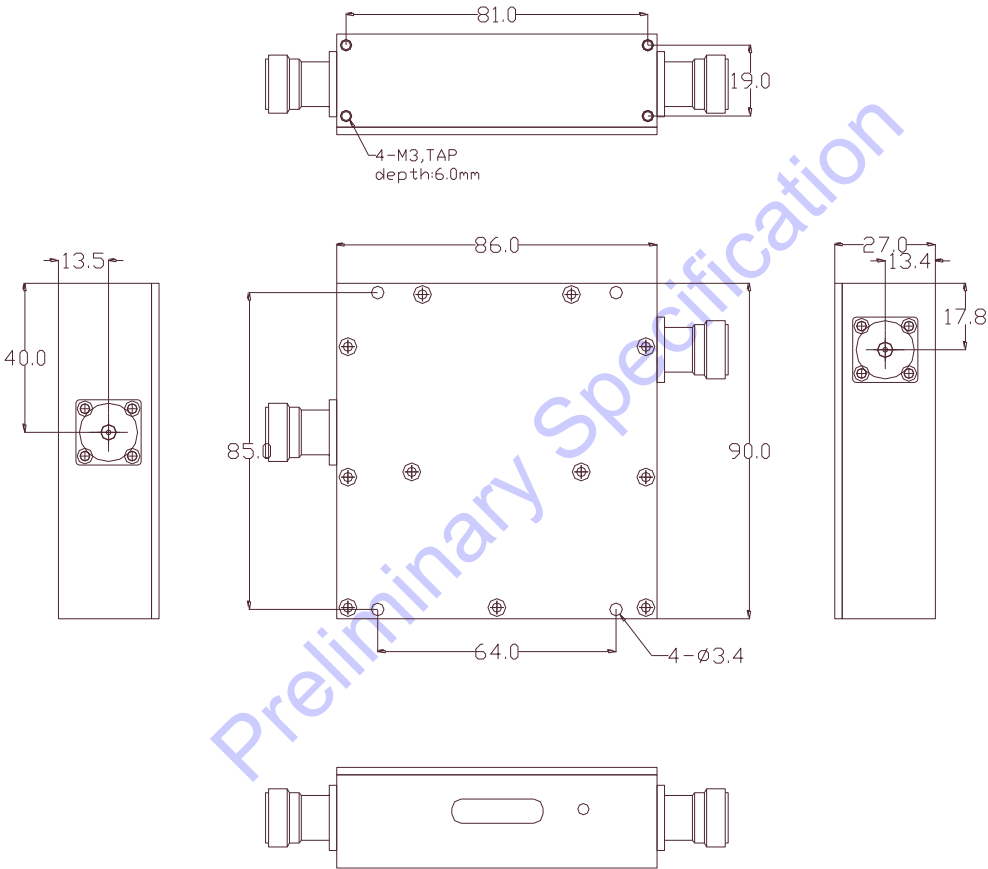

Specifications subject to change without notice.

Customer Service: Tel. 82-31-708-7575

Email: kijeon@rfcore.com

<http://www.rfcore.com>



This material is not to be supplied by other party than RFcore co., LTD